

# Data Sheet



Article number: 604132064050

Description: Taper bored timing belt pulley  
HTD 64 8M 50 TL 2517

## Measures

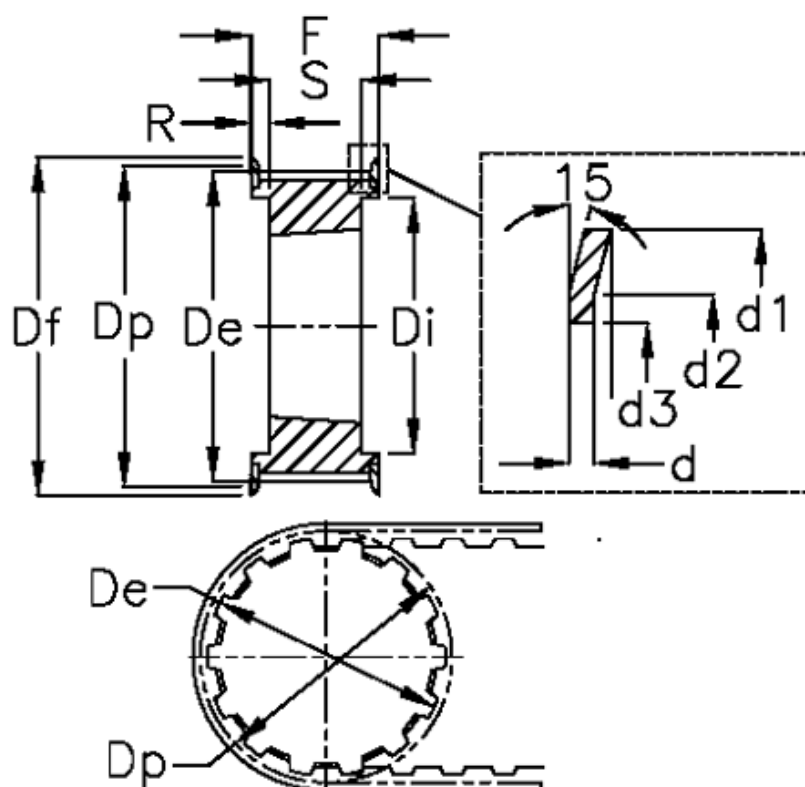

d = 1.5	F = 60	Weight = 5
d1 = 168	Flange type = F52	Width = 50
d2 = 161	For bushing = 2517	
d3 = 148	Max bore = 60	
De = 161.6	r = 7.5	
Df = 168	S = 45	
Di = 137	Tooth number = 64	
Dp = 162.97	Type = 8M	